

# РАЗМЕРЫ

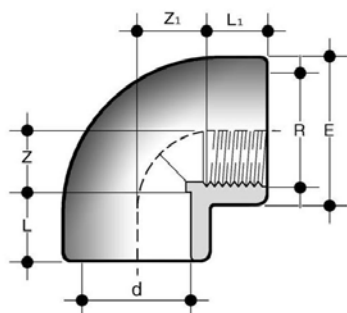

## GIFV

Отвод 90° с внутренней резьбой (R) с одной стороны и клеевым окончанием с другой (d)

d x R	PN	E	L	L1	Z	Z1	g	Артикул
16 x 3/8"	16	23.5	14	11.4	10	13	16	GIFV016038
20 x 1/2"	16	28.5	16	15	12	13	24	GIFV020012
25 x 3/4"	16	35	19	16.3	14	17	40	GIFV025034
32 x 1"	16	43	22	19.1	18	20.5	72	GIFV032100
40 x 1" 1/4	16	54	26	21.4	22.5	27	125	GIFV040114
50 x 1" 1/2	16	61	31	21.4	27	37	175	GIFV050112
63 x 2"	16	76	38	25.7	33	46	320	GIFV063200
75 x 2" 1/2	16	91	44	30.2	40.5	55	465	GIFV075212
90 x 3"	16	108	51	33.3	48	65.5	795	GIFV090300
110 x 4"	16	131	61	39.3	60	80	1130	GIFV110400

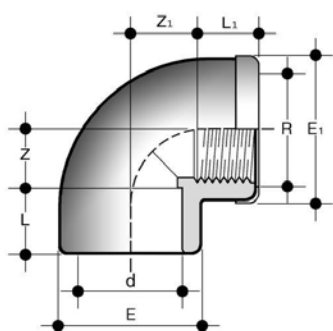

## GIMV

Отвод 90° с внутренней резьбой (R) с одной стороны с усиливающим металлическим кольцом и клеевым окончанием с другой (d)

d x R	PN	E	E1	L	L1	Z	Z1	g	Артикул
16 x 3/8"	16	23.5	24.5	14	11.4	10	13	20	GIMV016038
20 x 1/2"	16	28.5	29.5	16	15	12	13	30	GIMV020012
25 x 3/4"	16	35	36	19	16.3	14	17	48	GIMV025034
32 x 1"	16	43	44	22	19.1	18	20.5	85	GIMV032100
40 x 1" 1/4	16	54	55	26	21.4	22.5	27	130	GIMV040114
50 x 1" 1/2	16	61	62	31	21.4	27	37	185	GIMV050112
63 x 2"	16	76	77	38	25.7	33	46	345	GIMV063200

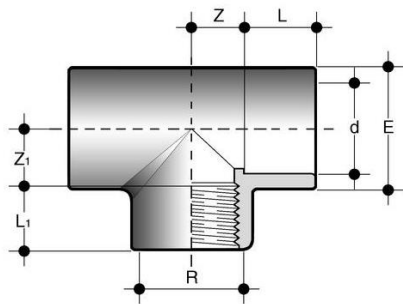

## TIFV

Тройник равносторонний 90° с внутренней резьбой @ с одной стороны и клеевым окончанием (d)

d x R	PN	E	L	L1	Z	Z1	g	Артикул
16 x 3/8"	16	23.5	14	11.4	9	11	20	TIFV016038
20 x 1/2"	16	28.5	16	15	12	13	32	TIFV020012
25 x 3/4"	16	35	19	16.3	15	17	52	TIFV025034
32 x 1/2"	16	41	22	15	17.5	18	92	TIFV032012
32 x 1"	16	43	22	19.1	18	21	71	TIFV032100
40 x 1" 1/4	16	50	26	21.4	21.5	27	110	TIFV040114
50 x 1/2"	16	61	31	15	27	27.5	160	TIFV050012
50 x 1" 1/2"	16	61	31	21.4	27	37	195	TIFV050112
63 x 1/2"	16	76	38	15	33.5	37.5	305	TIFV063012
63 x 2"	16	76	38	25.7	33.5	46	405	TIFV063200
75 x 2" 1/2	16	91	44	30.2	41	54.5	605	TIFV075212
90 x 3"	16	109	51	33.3	48.5	66	1070	TIFV090300
110 x 4"	16	133	61	39.3	61.5	83	1690	TIFV110400

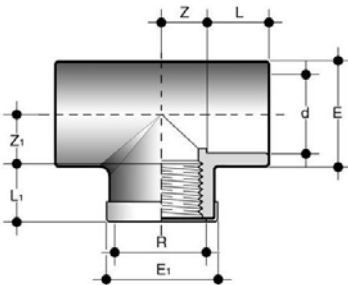

## TIMV

Тройник равносторонний 90° с внутренней резьбой (R) с одной стороны с усиливающим металлическим кольцом и клеевым окончанием (d)

d x R	PN	E	E1	L	L1	Z	Z1	g	Артикул
16 x 3/8"	16	23.5	24.5	14	11.4	9	11	24	TIMV016038
20 x 1/2"	16	28.5	29	16	15	12	13	38	TIMV020012
25 x 3/4"	16	35	36	19	16.3	15	17	60	TIMV025034
32 x 1"	16	43	44	22	19.1	18	21	105	TIMV032100
40 x 1" 1/4	16	50	51	26	21.4	21.5	27	125	TIMV040114
50 x 1" 1/2	16	61	62	31	21.4	27	37	210	TIMV050112
63 x 2"	16	76	77	38	25.7	33.5	46	415	TIMV063200

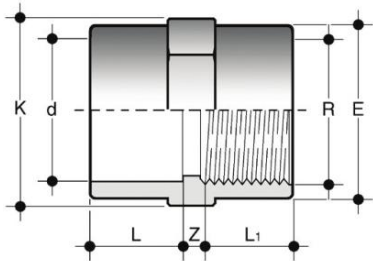

## MIFV

Переходная муфта с внутренней резьбой (R) с одной стороны и клеевым окончанием с другой (d)

d x R	PN	E	K	L	L1	Z	g	Артикул
16 x 3/8"	16	23.5	24	14	11.4	5.5	12	MIFV016038
20 x 1/2"	16	28.5	29	16	15	4	20	MIFV020012
25 x 3/4"	16	35	35	19	16.3	5	30	MIFV025034
32 x 1"	16	43	43	22	19.1	6	48	MIFV032100
40 x 1" 1/4	16	50	50	26	21.4	5	56	MIFV040114
50 x 1" 1/2	16	61	61	31	21.4	8	102	MIFV050112
63 x 2"	16	76	76	38	25.7	7.5	181	MIFV063200

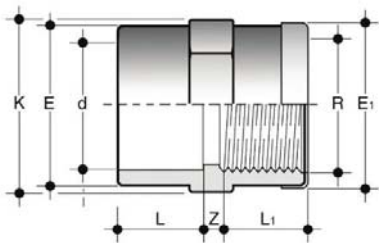

## MIMV

Переходная муфта с внутренней резьбой (R) с одной стороны с металлическим усиливающим кольцом и клеевым окончанием с другой (d)

d x R	PN	E	E1	K	L	L1	Z	g	Артикул
16 x 3/8"	16	23.5	24.5	24	14	11.4	5.5	14	MIMV016038
20 x 1/2"	16	28.5	29.5	29	16	15	4	23	MIMV020012
25 x 3/4"	16	35	36	35	19	16.3	5	34	MIMV025034
32 x 1"	16	43	44	43	22	19.1	6	53	MIMV032100
40 x 1" 1/4	16	50	51	50	26	21.4	5	62	MIMV040114
50 x 1" 1/2	16	61	62	61	31	21.4	8	110	MIMV050112
63 x 2"	16	76	77	76	38	25.7	7.5	190	MIMV063200

Fig. A

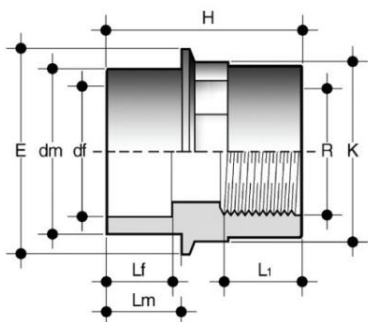

## DIFV

Двойной муфтовый адаптер с внутренней резьбой (R) с одной стороны и клеевым окончанием с другой (dm)  
Df – внутренний диаметр, dm - наружный

dm x df x R	PN	E	H	K	L1	Lf	Lm	g	Артикул
20 x 16 x 3/8"	16	28	36	24	11.4	14	16	11	DIFV020016038
25 x 20 x 1/2"	16	34	42	29	15	16	19	17	DIFV025020012
32 x 25 x 3/4"	16	40	49	35	16.3	19	22	26	DIFV032025034
40 x 32 x 1"	16	52	57	44	19.1	22	26	49	DIFV040032100
50 x 40 x 1"	16	59	67	54	21.4	26	31	66	DIFV050040114
63 x 50 x 1"	16	70	77	64	21.4	31	38	129	DIFV063050112

Fig. B

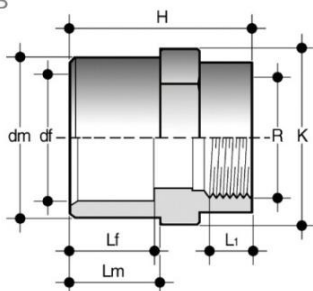

## DIFV

Двойной муфтовый адаптер с внутренней резьбой (R) с одной стороны и клеевым окончанием с другой (dm)  
Df – внутренний диаметр, dm – наружный

dm x df x R	PN	E	H	K	L1	Lf	Lm	g	Артикул
20 x 16 x 1/2"	16	-	39	30	15	14	16	18	DIFV020016012
25 x 20 x 3/4"	16	-	45	36	16.3	16	19	28	DIFV025020034
32 x 25 x 1"	16	-	51	46	19.1	19	22	49	DIFV032025100
40 x 32 x 1"	16	-	62	54	21.4	22	26	74	DIFV040032114
50 x 40 x 1"	16	-	72	65	21.4	26	31	127	DIFV050040112
63 x 50 x 2"	16	-	86	80	25.7	31	38	190	DIFV063050200
75 x 63 x 2"	16	-	76	76	25.7	38	44	180	DIFV075063200
75 x 63 x 2"	16	-	99	95	30.2	38	44	280	DIFV075063212
90 x 75 x 2"	16	-	84	95	30.2	44	51	300	DIFV090075212
90 x 75 x 3"	16	-	114	110	33.3	44	51	470	DIFV090075300
110 x 90 x 3"	16	-	100	110	33.3	51	61	450	DIFV110090300
110 x 90 x 4"	16	-	134	130	39.3	51	61	670	DIFV110090400
125 x 110 x 4"	16	-	111	131	39.3	61	69	550	DIFV125110400

Fig. A

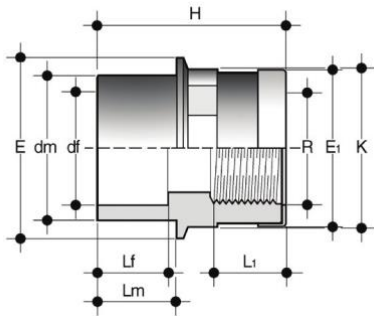

### DIMV

Двойной муфтовый адаптер с внутренней резьбой (R) с усиливающим металлическим кольцом с одной стороны и клеевым окончанием с другой (dm)

Df – внутренний диаметр, dm - наружный

dm x df x R	PN	E	E1	H	K	L1	Lf	Lm	g	Артикул
20 x 16 x 3/8"	16	28	24.5	37	24	11.4	14	16	13	DIMV020016038
25 x 20 x 1/2"	16	34	29.5	43	29	15	16	19	20	DIMV025020012
32 x 25 x 3/4"	16	40	36	50	35	16.3	19	22	32	DIMV032025034
40 x 32 x 1"	16	52	44	58	44	19.1	22	26	58	DIMV040032100
50 x 40 x 1"	16	59	55	68	54	21.4	26	31	77	DIMV050040114
63 x 50 x 1"	16	70	62	78	64	21.4	31	38	143	DIMV063050112

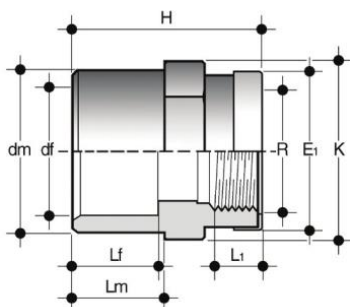

### DIMV

Двойной муфтовый адаптер с внутренней резьбой (R) с усиливающим металлическим кольцом с одной стороны и клеевым окончанием с другой (dm)

Df – внутренний диаметр, dm - наружный

dm x df x R	PN	E	E1	H	K	L1	Lf	Lm	g	Артикул
20 x 16 x 1/2"	16	-	29.5	40	30	15	14	16	21	DIMV020016012
25 x 20 x 3/4"	16	-	36	46	36	16.3	16	19	34	DIMV025020034
32 x 25 x 1"	16	-	44	52	46	19.1	19	22	58	DIMV032025100
40 x 32 x 1"	16	-	55	63	54	21.4	22	26	85	DIMV040032114
50 x 40 x 1"	16	-	62	73	65	21.4	26	31	141	DIMV050040112
63 x 50 x 2"	16	-	77	87	80	25.7	31	38	212	DIMV063050200
75 x 63 x 2"	16	-	77	77	76	25.7	38	44	202	DIMV075063200

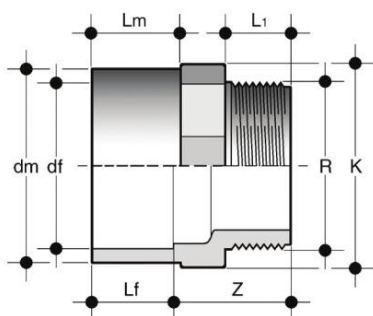

## KIFV

Двойной муфтовый адаптер с наружной резьбой (R) с одной стороны и клеевым окончанием с другой (dm)

Df – внутренний диаметр, dm - наружный

dm x df x R	PN	K	L1	Lm	Lf	Z	g	Артикул
16 x 12 x 3/8"	16	18	11.4	14	12.5	21	4	KIFV016012038
20 x 16 x 3/8"	16	22	11.4	16	14	20	6	KIFV020016038
20 x 16 x 1/2"	16	22	15	16	14	23.5	10	KIFV020016012
25 x 20 x 1/2"	16	28	15	19	16	25	12	KIFV025020012
25 x 20 x 3/4"	16	28	16.3	19	16	25.5	17	KIFV025020034
32 x 25 x 1/2"	16	34	15	22	19	25.5	15	KIFV032025012
32 x 25 x 3/4"	16	34	16.3	22	19	27	21	KIFV032025034
32 x 25 x 1"	16	34	19.1	22	19	29.5	27	KIFV032025100
40 x 32 x 3/4"	16	42	15	26	22	27.5	28	KIFV040032034
40 x 32 x 1"	16	42	19.1	26	22	30.5	34	KIFV040032100
40 x 32 x 1" 1/4	16	42	21.4	26	22	32.5	40	KIFV040032114
50 x 40 x 1"	16	52	19.1	31	26	31.5	50	KIFV050040100
50 x 40 x 1" 1/4	16	52	21.4	31	26	35	60	KIFV050040114
50 x 40 x 1" 1/2	16	52	21.4	31	26	35	70	KIFV050040112
63 x 50 x 1" 1/4	16	65	21.4	38	31	37	95	KIFV063050114
63 x 50 x 1" 1/2	16	65	21.4	38	31	35	105	KIFV063050112
63 x 50 x 2"	16	65	25.7	38	31	39.5	150	KIFV063050200
75 x 63 x 1" 1/2	16	75	21.4	44	38	38	125	KIFV075063112
75 x 63 x 2"	16	75	25.7	44	38	41	145	KIFV075063200
75 x 63 x 2" 1/2	16	75	30.2	44	38	46.5	155	KIFV075063212
90 x 75 x 2"	16	95	25.7	51	44	49	275	KIFV090075200
90 x 75 x 2" 1/2	16	95	30.2	51	44	54	280	KIFV090075212
90 x 75 x 3"	16	95	33.5	51	44	56	300	KIFV090075300
110 x 90 x 2" 1/2	16	110	30.2	61	51	57	370	KIFV110090212
110 x 90 x 3"	16	110	33.5	61	51	62	390	KIFV110090300
110 x 90 x 4"	16	128	39.2	61	51	77	420	KIFV110090400
125 x 110 x 3"	16	128	33.5	69	61	59	450	KIFV125110300
125 x 110 x 4"	16	128	39.2	69	61	65	500	KIFV125110400

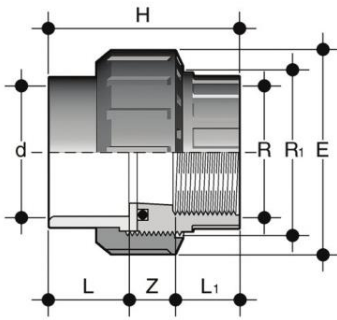

## BIFV

Муфта разборная (американка) с внутренней резьбой (R) с одной стороны и клеевым окончанием с другой (d), уплотнение EPDM

d x R	R1	PN	E	H	L	L1	Z	g	Артикул
16 x 3/8"	3/4"	16	33	41	14	11.4	15.6	22	BIFV016038E
20 x 1/2"	1"	16	41	45	16	15	14	35	BIFV020012E
25 x 3/4"	1" 1/4	16	50	51	19	16.3	15.7	62	BIFV025034E
32 x 1"	1" 1/2	16	58	57	22	19.1	15.9	85	BIFV032100E
40 x 1" 1/4	2"	16	72	67	26	21.4	19.6	145	BIFV040114E
50 x 1" 1/2	2" 1/4	16	79	72	31	21.4	19.6	180	BIFV050112E
63 x 2"	2" 3/4	16	98	88	38	25.7	24	315	BIFV063200E
75 x 2" 1/2	3" 1/2	10	120	116	44	30.2	34.8	630	BIFV075212E
90 x 3"	4"	10	135	125	51	33.3	40.7	810	BIFV090300E
110 x 4"	5"	10	163	145	61	39.3	44.7	1350	BIFV110400E

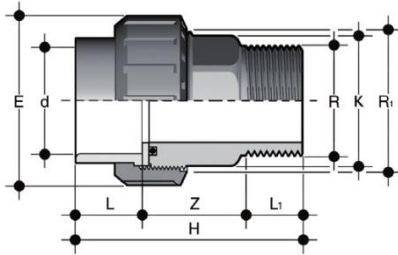

## BIRV

Муфта разборная (американка) с наружной резьбой (R) с одной стороны и клеевым окончанием с другой (d), уплотнение EPDM

d x R	R1	PN	E	H	K	L	L1	Z	g	Артикул
50 x 1" 1/2	2" 1/4	16	79	98	53	31	21.4	45.6	200	BIRV050112E
50 x 2"	2" 1/4	16	79	102	53	31	25.7	45.3	220	BIRV050200E
63 x 2"	2" 3/4	16	98	116	67	38	25.7	52.3	380	BIRV063200E

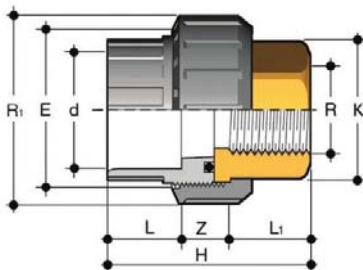

## BIFOV

Муфта разборная (американка) с внутренней резьбой из латуни (R) с одной стороны и клеевым окончанием с другой (d), уплотнение EPDM

d x R	R1	PN	E	H	K	L	L1	Z	g	Артикул
16 x 3/8"	3/4"	16	33	45.5	20	14	13.5	18	53	BIFOV016038E
20 x 1/2"	1"	16	41	48.5	25	16	16.5	16	86	BIFOV020012E
25 x 3/4"	1" 1/4	16	50	54.5	32	19	18.5	17	161	BIFOV025034E
32 x 1"	1" 1/2	16	58	59.5	38	22	19.5	18	181	BIFOV032100E
40 x 1" 1/4	2"	16	72	68.5	48	26	21.5	21	373	BIFOV040114E
50 x 1" 1/2	2" 1/4	16	79	84.5	55	31	23	24.5	460	BIFOV050112E
63 x 2"	2" 3/4	16	98	94.5	69	38	27	29.5	824	BIFOV063200E

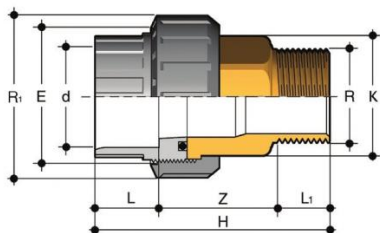

## BIROV

Муфта разборная (американка) с наружной резьбой из латуни (R) с одной стороны и клеевым окончанием с другой (d), уплотнение EPDM

d x R	R1	PN	E	H	K	L	L1	Z	g	Артикул
16 x 3/8"	3/4"	16	33	58.5	20	14	10.5	34	79	BIROV016038E
20 x 1/2"	1"	16	41	65	25	16	13.5	35.5	131	BIROV020012E
25 x 3/4"	1" 1/4	16	50	72.5	32	19	15	38.5	229	BIROV025034E
32 x 1"	1" 1/2	16	58	80	38	22	17.5	40.5	288	BIROV032100E
40 x 1" 1/4	2"	16	72	91	48	26	19.5	45.5	550	BIROV040114E
50 x 1" 1/2	2" 1/4	16	79	101	55	31	19.5	50.5	681	BIROV050112E
63 x 2"	2" 3/4	16	98	122.5	69	38	24	60.5	1183	BIROV063200E

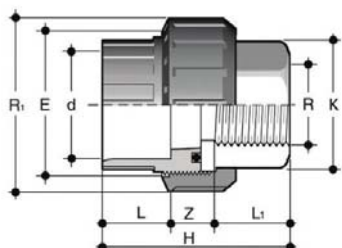

## BIFXV

Муфта разборная (американка) с внутренней резьбой из стали A316L (R) с одной стороны и клеевым окончанием с другой (d), уплотнение EPDM или FPM

d x R	R1	PN	E	H	K	L	L1	Z	g	EPDM Артикул	FPM Артикул
16 x 3/8"	3/4"	16	33	45.5	20	14	13.5	18	50	BIFXV016038E	BIFXV016038F
20 x 1/2"	1"	16	41	48.5	25	16	16.5	16	81	BIFXV020012E	BIFXV020012F
25 x 3/4"	1" 1/4	16	50	54.5	32	19	18.5	17	152	BIFXV025034E	BIFXV025034F
32 x 1"	1" 1/2	16	58	59.5	38	22	19.5	18	170	BIFXV032100E	BIFXV032100F
40 x 1" 1/4	2"	16	72	68.5	48	26	21.5	21	353	BIFXV040114E	BIFXV040114F
50 x 1" 1/2	2" 1/4	16	79	84.5	55	31	23	30.5	435	BIFXV050112E	BIFXV050112F
63 x 2"	2" 3/4	16	98	94.5	69	38	27	29.5	779	BIFXV063200E	BIFXV063200F

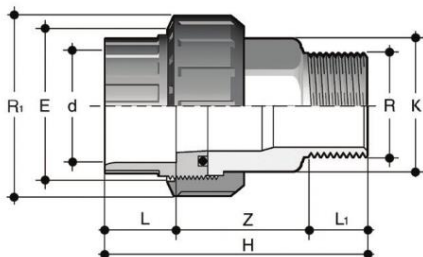

## BIRXV

Муфта разборная (американка) с наружной резьбой из стали A316L (R) с одной стороны и клеевым окончанием с другой (d), уплотнение EPDM или FPM

d x R	R1	PN	E	H	K	L	L1	Z	g	EPDM Артикул	FPM Артикул
16 x 3/8"	3/4"	16	33	58.5	20	14	10.5	34	74	BIRXV016038E	BIRXV016038F
20 x 1/2"	1"	16	41	65	25	16	13.5	35.5	123	BIRXV020012E	BIRXV020012F
25 x 3/4"	1" 1/4	16	50	72.5	32	19	15	38.5	215	BIRXV025034E	BIRXV025034F
32 x 1"	1" 1/2	16	58	80	38	22	17.5	40.5	269	BIRXV032100E	BIRXV032100F
40 x 1" 1/4	2"	16	72	91	48	26	19.5	45.5	516	BIRXV040114E	BIRXV040114F
50 x 1" 1/2	2" 1/4	16	79	101	55	31	19.5	50.5	639	BIRXV050112E	BIRXV050112F
63 x 2"	2" 3/4	16	98	122.5	69	38	24	60.5	1111	BIRXV063200E	BIRXV063200F



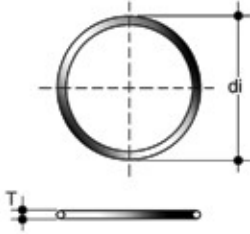

## O-Ring

O-Ring для муфт типа BIV, BIFV, BVFV, BLV, BIRV, BIFOV, BIROV, BIFXV, BIRXV

Union d	C	di	T	EPDM Артикул	FPM Артикул
16	3062	15.54	2.62	OR3062E	OR3062F
20	4081	20.22	3.53	OR4081E	OR4081F
25	4112	28.17	3.53	OR4112E	OR4112F
32	4131	32.93	3.53	OR4131E	OR4131F
40	6162	40.65	5.34	OR6162E	OR6162F
50	6187	47	5.34	OR6187E	OR6187F
63	6237	59.69	5.34	OR6237E	OR6237F
75	6300	75.57	5.34	OR6300E	OR6300F
90	6362	91.45	5.34	OR6362E	OR6362F
110	6450	113.67	5.34	OR6450E	OR6450F

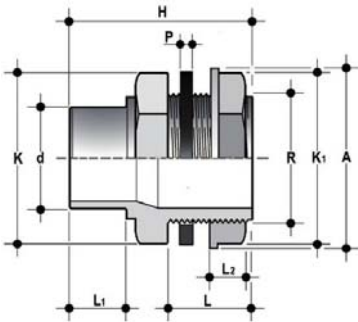

## LIV

Фитинг для соединения с цистерной, уплотнение EPDM

d x R	PN	A	H	K	K1	L	L1	L2	P	g	Артикул
25 x 1"	16	58	60	46	46	26	19	16	2	58	LIV025100
32 x 1" 1/4	16	62	66	55	50	28	22	18	2	90	LIV032114

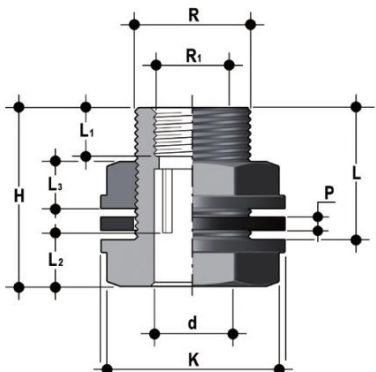

## LIFV

Фитинг для соединения с цистерной с наружной резьбой (R), уплотнение EPDM или FPM

d x R x R1	PN	A	H	K	L	L1	L2	L3	P	g	EPDM Артикул	FPM Артикул
16 x 3/4" x	16	44	60.5	33	47	15	14	13.5	3	53	LIFV016034012E	LIFV016034012F
20 x 1" x 3/4"	16	58	65	46	49	16.3	16	16	3	108	LIFV020100034E	LIFV020100034F
25x 1" 1/4 x 1"	16	62	70	50	52	19.1	19	18	3	142	LIFV025114100E	LIFV025114100F
32 x 1" 1/2 x 1"	16	76	73	60	54	19.1	22	19	3	192	LIFV032112100E	LIFV032112100F
40 x 2" x 1" 1/2	16	92	81	79	60	21.4	26	20.8	3	337	LIFV040200112E	LIFV040200112F