



ФИТИНГИ ИЗ ПВХ

ТЕХНИЧЕСКИЙ КАТАЛОГ

Ассортимент фитингов из ПВХ содержит полную линейку компонентов для химической сварки в раструб, резьбовых и переходных, предназначенных для транспортировки рабочих сред под давлением при рабочей температуре не выше 60°C.

WWW.PVCPIPE.COM.UA

ФИТИНГИ ИЗ ПВХ

ПВХ фитинги,
производимые
компанией FIP,
подходят для
транспортировки
воды или
питательных
веществ и
соответствуют всем
необходимым
стандартам

Техническая спецификация	
Диапазон диаметров:	d 12 ÷ d 500 (mm)
Рабочее давление:	PN 16 при температуре воды 20 °C
Диапазон рабочих температур:	0 °C ÷ 60 °C
Стандарты соединений:	Клеевое соединение: ISO 727, EN ISO 15493, DIN 8063, EN ISO 1452, ASTM D 2467, JIS K 6743, BS 4346-1. Для соединений с трубами, которые соответствуют стандарту ISO 161-1, EN ISO 1452, EN ISO 15493, DIN 8062, ASTM D1785, JIS K6741, BS 3505-3506. Фланцы: DIN 2501, EN 1092-1
Применимые стандарты:	Конструктивные критерии: EN ISO 1452, EN ISO 15493 Методики и требования к тестированию: EN ISO 1452, EN ISO 15493 Критерии монтажа: DVS 2204, DVS 2221, UNI 11242
Материал фитингов:	ПВХ (PVC-U)
Уплотняющие прокладки:	EPDM, FPM

ТЕХНИЧЕСКИЕ ДАННЫЕ

ГРАФИК ЗАВИСИМОСТИ ТЕМПЕРАТУРЫ ОТ ДАВЛЕНИЯ

График соотношения температура/давление для воды и сред, нейтральных для ПВХ. При использовании химически агрессивных сред необходимо снизить номинальное давление

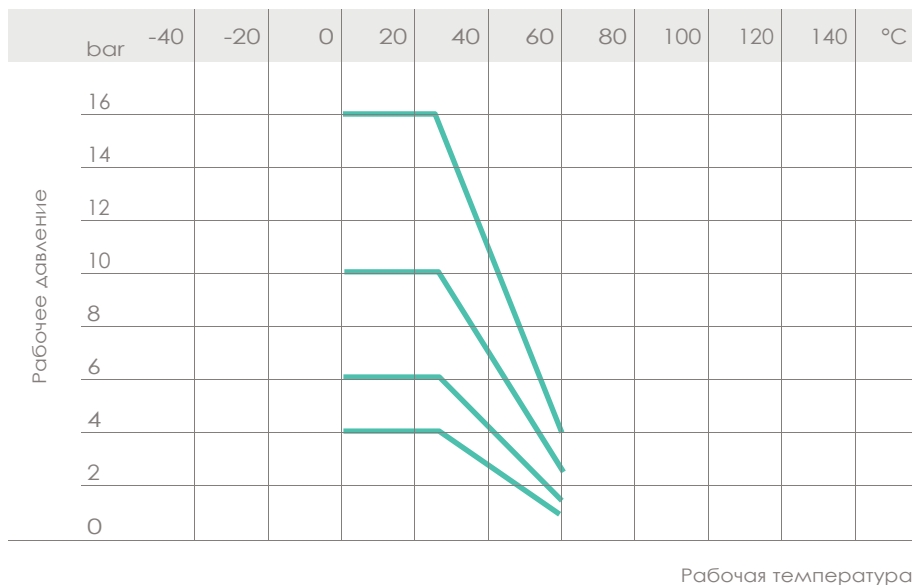

Рабочая температура

ГРАФИК ИСПЫТИЙ НА ДЛИТЕЛЬНОЕ МАКСИМАЛЬНОЕ ДАВЛЕНИЕ ДЛЯ ФИТИНГОВ

Regression coefficients according to EN ISO 1452 and EN ISO 15493 for MRS (minimum required strength) values = 25 N/mm² (MPa) (classification PVC-U 250).

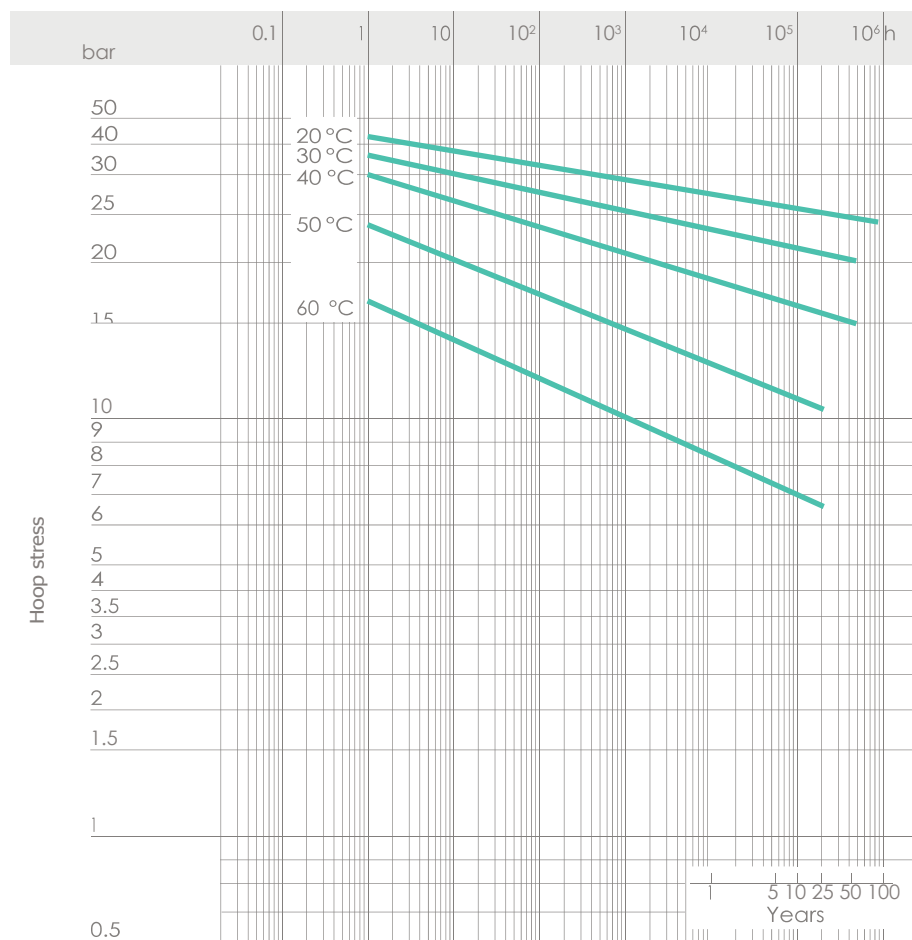

Time to failure

РАЗМЕРЫ

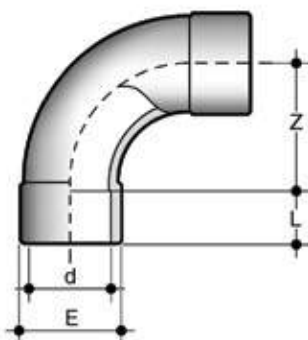

SIV

Отвод большого радиуса 90°

	d	PN	E	L	Z	g	Артикул
ИН	20	16	27	16	40.5	35	SIV020
ИН	25	16	33	19	50	55	SIV025
ИН	32	16	41	22	65.5	100	SIV032
ИН	40	16	50	26	80.5	175	SIV040
ИН	50	16	61	31	100.5	280	SIV050
ИН	63	16	76	38	127	515	SIV063
I	75	16	94	44	150	1000	SIV075
I	90	16	113	51	180	1770	SIV090
I	110	16	137	61	220	2800	SIV110
I	*160	16	189	86	207	5020	SIV160

I: ИП 122 Н: KIWA K5034 ND 10
*reduced safety factor (PN 10)

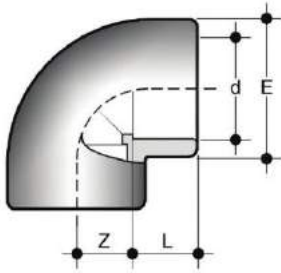

GIV
Отвод 90°

	d	PN	E	L	Z	g	Артикул
	12	16	17	12	8	4	GIV012
IFH	16	16	22	14	9	11	GIV016
IFH	20	16	26	16	12	15	GIV020
IFH	25	16	32	19	15	30	GIV025
IFH	32	16	40	22	19	50	GIV032
IFH	40	16	50	26	22	90	GIV040
IFH	50	16	59	31	27.5	160	GIV050
IFH	63	16	76	38	33.5	290	GIV063
IF	75	16	91	44	41	450	GIV075
IF	90	16	108	51	47.5	680	GIV090
IF	110	16	130	61	61	1180	GIV110
IF	125	16	148	69	64	1650	GIV125
IF	140	16	163	76	77	2080	GIV140
IF	160	16	193	86	89	3980	GIV160
	*180	16	215	96	94	5200	GIV180
	*200	16	229	106	100	5360	GIV200

I: IIP 122 F: AFNOR NF04 H: KIWA K5034 ND 10
*reduced safety factor

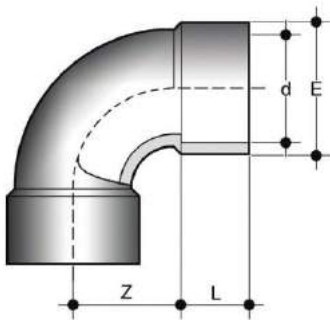

GIV
Отвод 90°

d	PN	E	L	Z	g	Артикул
*225	16	258	119	171.5	8700	GIV225
250	10	287	131	188	12480	GIV250
280	10	325	147	210	17000	GIV280
315	10	359	164	236	23370	GIV315

*reduced safety factor

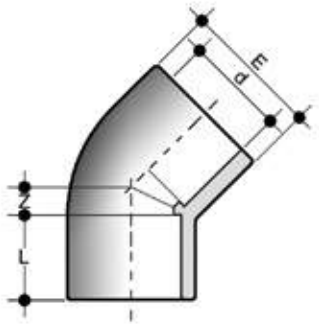

HIV

Отвод 45°

	d	PN	E	L	Z	g	Артикул
	12	16	17	12	4	5	HIV012
	16	16	21	14	5	6	HIV016
IFH	20	16	28	16	5.5	20	HIV020
IFH	25	16	33	19	6	26	HIV025
IFH	32	16	41	22	7.5	45	HIV032
IFH	40	16	50	26	10.5	70	HIV040
IFH	50	16	61	31	11.5	120	HIV050
IFH	63	16	76	38	14	200	HIV063
IF	75	16	90	44	17	320	HIV075
IF	90	16	107	51	21.5	550	HIV090
IF	110	16	130	61	26	915	HIV110
IF	125	16	147	69	31	1315	HIV125
IF	140	16	163	76	34	1660	HIV140
IF	160	16	192	86	38	3060	HIV160
	**180	4	208	97	38	3500	HIV180
	200	10	230	108	48	4500	HIV200
	225	10	260	121	55	6400	HIV225
	250	10	286	131	58	7700	HIV250
	280	10	320	146	62	10460	HIV280
	315	10	359	164	66	15500	HIV315

I: IIP 122 F: AFNOR NF04 H: KIWA K5034 ND 10
 **resale product

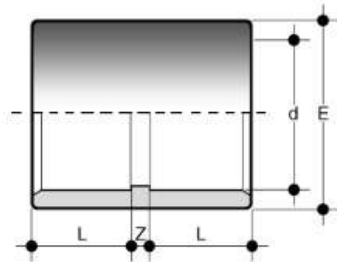

MIV

Муфта соединительная

	d	PN	E	L	Z	g	Артикул
	12	16	17	12	3	3	MIV012
F	16	16	21	14	3	7	MIV016
HIF	20	16	26	16	3	11	MIV020
HIF	25	16	32	19	3	20	MIV025
HIF	32	16	40	22	3	30	MIV032
HIF	40	16	50	26	3	55	MIV040
HIF	50	16	61	31	3	90	MIV050
HIF	63	16	76	38	3	160	MIV063
IF	75	16	90	44	3	250	MIV075
IF	90	16	108	51	4	415	MIV090
IF	110	16	131	61	8	715	MIV110
IF	125	16	148	69	7	960	MIV125
IF	140	16	164	76	8	1240	MIV140
IF	160	16	186	86	9	1680	MIV160
	**180	4	209	96	8	2500	MIV180
	*200	16	232	106	11	3050	MIV200
	*225	16	260	119	11	4600	MIV225
	250	10	286	131	10	5760	MIV250
	280	10	320	146	10	7630	MIV280
	315	10	355	164	12	9780	MIV315

I: IIP 122 F: AFNOR NF04 H: KIWA K5034 ND 10

*reduced safety factor

**resale product

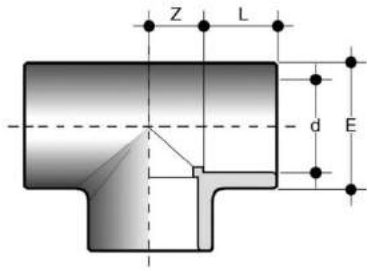

TIV

Тройник равносторонний 90°

	d	PN	E	L	Z	g	Артикул
	12	16	17	12	8	6	TIV012
FH	16	16	22	14	9	15	TIV016
IFH	20	16	27	16	11	25	TIV020
IFH	25	16	33	19	14	40	TIV025
IFH	32	16	40	22	18	65	TIV032
IFH	40	16	49	26	22	114	TIV040
IFH	50	16	61	31	27	185	TIV050
IFH	63	16	76	38	34	380	TIV063
IF	75	16	91	44	40.5	605	TIV075
IF	90	16	109	51	48.5	985	TIV090
IF	110	16	133	61	61	1760	TIV110
IF	125	16	151	69	64	2430	TIV125
IF	140	16	174	76	77	4150	TIV140
IF	160	16	193	86	88	5250	TIV160
	180	16	215	96	94	6180	TIV180
	*200	16	228	106	101	6810	TIV200
	*225	16	258	119	114	12680	TIV225
	250	10	286	131	128	13250	TIV250
	280	10	319	146	144	17840	TIV280
	315	10	360	164	162	25300	TIV315

I: IIP 122 F: AFNOR NF04 H: KIWA K5034 ND 10
*reduced safety factor

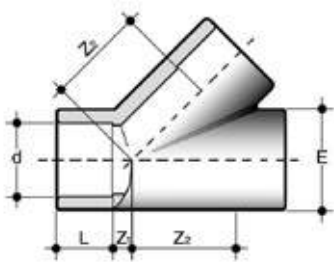

YIV

Тройник 45°

d	PN	E	L	Z1	Z2	g	Артикул
20	16	27	16	7	30	39	YIV020
25	16	33	19	7	35	62	YIV025
32	16	41	22	9	44	110	YIV032
40	16	51	26	11	55	190	YIV040
50	16	63	31	12	68.5	335	YIV050
63	16	78	38	15	85	570	YIV063
**160	4	189	86	35	200	6500	YIV160

**resale product

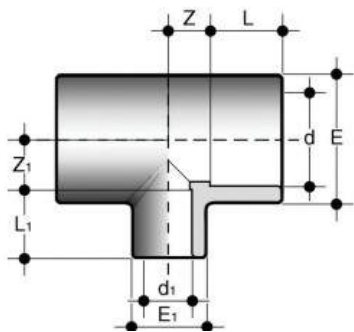

TRIV

Тройник 90° переходной

d x d1	PN	E	E1	L	L1	Z	Z1	g	Артикул
25 x 20	16	33	28	19	16	14	14	37	TRIV025020
32 x 20	16	41	28	22	16	17.5	17.5	60	TRIV032020
32 x 25	16	41	34	22	19	17.5	17.5	65	TRIV032025
40 x 20	16	50	29	26	16	22	22	100	TRIV040020
40 x 25	16	50	34	26	19	22	22	100	TRIV040025
40 x 32	16	50	42	26	22	22	22	105	TRIV040032
50 x 20	16	61	30	31	16	27	27	160	TRIV050020
50 x 25	16	61	35	31	19	27	27	160	TRIV050025
50 x 32	16	61	42	31	22	27	27	165	TRIV050032
50 x 40	16	61	51	31	26	27	27	170	TRIV050040
63 x 25	16	76	36	38	19	33.5	33.5	290	TRIV063025
63 x 32	16	76	43	38	22	33.5	33.5	295	TRIV063032
63 x 40	16	76	52	38	26	33.5	33.5	300	TRIV063040
63 x 50	16	76	62	38	31	33.5	33.5	315	TRIV063050
75 x 32	16	91	41	44	22	40	40	530	TRIV075032
75 x 40	16	91	50	44	26	40	40	540	TRIV075040
75 x 50	16	91	61	44	31	40	40	550	TRIV075050
75 x 63	16	91	76	44	38	40	40	580	TRIV075063
90 x 40	16	109	50	51	26	48	48	870	TRIV090040
90 x 50	16	109	61	51	31	48	48	880	TRIV090050
90 x 63	16	109	76	51	38	48	48	900	TRIV090063
90 x 75	16	109	91	51	44	48	48	940	TRIV090075
110 x 50	16	133	61	61	31	61	61	1580	TRIV110050
110 x 63	16	133	76	61	38	61	61	1590	TRIV110063
110 x 75	16	133	91	61	44	61	61	1610	TRIV110075
110 x 90	16	133	109	61	51	61	61	1640	TRIV110090
**160 x 110	16	187	131	86	61	59	84	3450	TRIV160110
180 x 125	16	215	151	96	69	94	94	6760	TRIV180125
**250 x 110	4	285	134	129	63	61	128	8300	TRIV250110
**250 x 160	4	285	193	129	87	86	129	9900	TRIV250160
**250 x 200	4	285	228	129	106	133	132	12000	TRIV250200
**280 x 160	4	320	193	146	88	84	153	12500	TRIV280160
**280 x 225	4	320	258	146	117.5	117	150.5	14900	TRIV280225
**315 x 160	4	355	193	164	86	83	161	15000	TRIV315160
**315 x 200	4	355	228	164	106	102	179	17500	TRIV315200
**315 x 250	4	355	285	164	131	127	160	19200	TRIV315250

**resale product

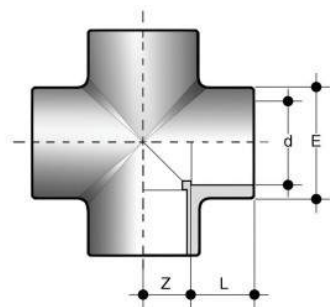

XIV
Крестовина 90°

	d	PN	E	L	Z	g	Артикул
H	25	16	35	19	14	60	XIV025
H	32	16	43	22	18	105	XIV032
H	40	16	52	26	23	175	XIV040
H	50	16	64	31	27	265	XIV050
H	63	16	79	38	33.5	505	XIV063

H: KIWA K5034 ND 10

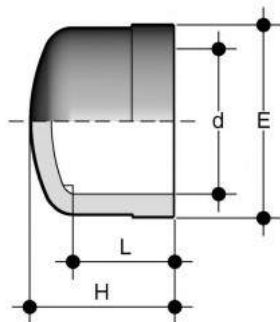

CIV
Заглушка

	d	PN	E	H	L	g	Артикул
	12	16	17	15	12	3	CIV012
F	16	16	21	17	15	4	CIV016
IF	20	16	28	23	16	9	CIV020
IF	25	16	34	27	19	15	CIV025
IF	32	16	41	31	22	25	CIV032
IF	40	16	51	36	26	40	CIV040
IF	50	16	62	43	31	60	CIV050
IF	63	16	77	51	38	110	CIV063
IF	75	16	91	59	44	190	CIV075
IF	90	16	110	69	51	330	CIV090
IF	110	16	133	85	61	575	CIV110
IF	125	16	147	99	69	900	CIV125
	140	16	164	108	76	1100	CIV140
	160	16	192	128	86	1900	CIV160
	225	10	260	163	119	3000	CIV225

I: IIP 122 F: AFNOR NF04

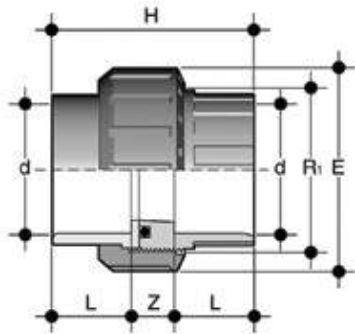

BIV

Муфта разборная (американка), уплотнения из EPDM или FPM

	d	R1	PN	E	H	L	Z	g	Артикул
I	16	3/4"	16	33	41	14	13	20	BIV016E
I	20	1"	16	41	45	16	13	35	BIV020E
I	25	1" 1/4	16	50	51	19	13	60	BIV025E
I	32	1" 1/2	16	58	57	22	13	85	BIV032E
I	40	2"	16	72	67	26	15	150	BIV040E
I	50	2" 1/4	16	79	79	31	17	175	BIV050E
I	63	2" 3/4	16	98	98	38	22	320	BIV063E
	75	3" 1/2	10	120	116	44	21	590	BIV075E
	90	4"	10	135	125	51	23	770	BIV090E
	110	5"	10	163	145	61	23	1300	BIV110E

I: ИР 122

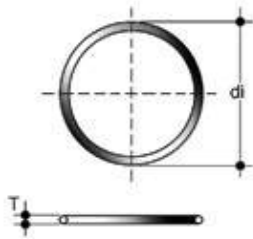

O-Ring

Уплотнительное кольцо для BIV, BIVV, BVV, BLV, BIRV, BIFOV, BIROV, BIFXV, BIRXV

d	C	di	T	EPDM Артикул	FPM Артикул
16	3062	15.54	2.62	OR3062E	OR3062F
20	4081	20.22	3.53	OR4081E	OR4081F
25	4112	28.17	3.53	OR4112E	OR4112F
32	4131	32.93	3.53	OR4131E	OR4131F
40	6162	40.65	5.34	OR6162E	OR6162F
50	6187	47	5.34	OR6187E	OR6187F
63	6237	59.69	5.34	OR6237E	OR6237F
75	6300	75.57	5.34	OR6300E	OR6300F
90	6362	91.45	5.34	OR6362E	OR6362F
110	6450	113.67	5.34	OR6450E	OR6450F

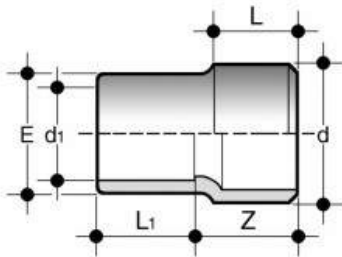

RIV

Втулка переходная удлиненная
Соединение: d – втулочное соединение, d1 – муфтовое соединение меньшего диаметра

	d x d1	PN	E	L	L1	Z	g	Артикул
I	16 x 12	16	19	14	12	18	7	RIV016012
IF	20 x 16	16	22	16	14	21	8	RIV020016
F	160 x 110	16	137	86	61	125	1270	RIV160110
	200 x 160	10	182	106	86	156	2540	RIV200160

I: IIP 122 F: AFNOR NF04

RIV: the quality marks refer to dimensions d and d1

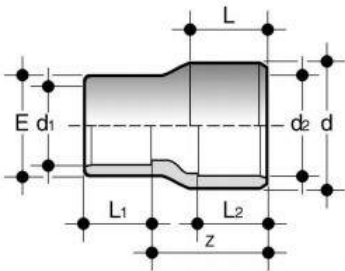

RIV

Втулка переходная удлиненная
Соединение: d – втулочное соединение, d1 – муфтовое соединение меньшего диаметра

	d x d2 x d1	PN	E	L	L1	L2	Z	g	Артикул
IF	25 x 20 x 16	16	22	19	14	16	24.5	9	RIV025020016
IF	25 x 20 x 20	16	26	19	16	16	24.5	12	RIV025020020
IF	32 x 25 x 16	16	22	22	14	19	30	14	RIV032025016
IF	32 x 25 x 20	16	27	22	16	19	30	16	RIV032025020
IF	32 x 25 x 25	16	32	22	19	19	30	20	RIV032025025
IF	40 x 32 x 20	16	27	26	16	22	36	23	RIV040032020
IF	40 x 32 x 25	16	32	26	19	22	36	27	RIV040032025
IF	40 x 32 x 32	16	41	26	22	22	36	34	RIV040032032
I	50 x 40 x 20	16	27	31	16	26	44	36	RIV050040020
IF	50 x 40 x 25	16	32	31	19	26	44	40	RIV050040025
IF	50 x 40 x 32	16	40	31	22	26	44	48	RIV050040032
IF	50 x 40 x 40	16	48	31	26	26	44	55	RIV050040040
I	63 x 50 x 25	16	32	38	19	31	54	75	RIV063050025
IF	63 x 50 x 32	16	40	38	22	31	54	80	RIV063050032
IF	63 x 50 x 40	16	49	38	26	31	54	90	RIV063050040
IF	63 x 50 x 50	16	60	38	31	31	54	110	RIV063050050
IF	75 x 63 x 50	16	61	44	31	38	62	130	RIV075063050
IF	75 x 63 x 63	16	76	44	38	38	62	175	RIV075063063
I	110 x 90 x 50	16	61	61	31	51	88	260	RIV110090050
I	110 x 90 x 63	16	76	61	38	51	88	300	RIV110090063
I	110 x 90 x 75	16	89	61	44	51	88	345	RIV110090075
IF	110 x 90 x 90	16	104	61	51	51	88	400	RIV110090090

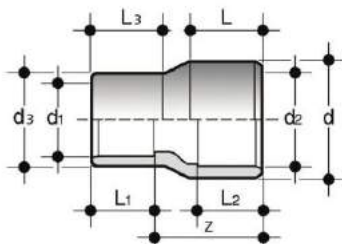

RIV

Втулка переходная удлиненная
Соединение: d – втулочное соединение, d1 – муфтовое соединение меньшего диаметра, d1 – муфтовое соединение

	d x d2 x d3 x d1	PN	E	L	L1	L2	L3	Z	g	Артикул
I	90 x 75 x 50 x 40	16	-	51	26	44	31	74	180	RIV090075050040
IF	90 x 75 x 63 x 50	16	-	51	31	44	38	74	200	RIV090075063050
IF	90 x 75 x 75 x 63	16	-	51	38	44	44	74	260	RIV090075075063
IF	90 x 75 x 90 x 75	16	-	51	44	44	51	74	325	RIV090075090075

Fig. A

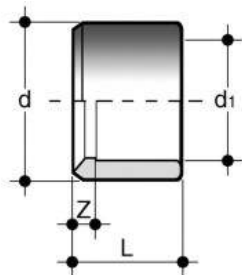

DIV

Переходное кольцо

Клеевое соединение d – для внешнего диаметра, d1 – для внутреннего (fig. A)

	d x d1	PN	L	Z	g	Артикул
	16 X 12	16	14	2	1	DIV016012
IF	20 X 16	16	16	2	3	DIV020016
IF	25 X 20	16	19	3	5	DIV025020
I	32 X 20	16	22	6	15	DIV032020
IF	32 X 25	16	22	3.5	10	DIV032025
IF	40 X 32	16	26	4	17	DIV040032
IF	50 X 40	16	31	5	32	DIV050040
IF	63 X 50	16	38	7	65	DIV063050
IF	75 X 63	16	44	6	85	DIV075063
IF	90 X 75	16	51	7	150	DIV090075
IF	110 X 90	16	61	9	270	DIV110090
IF	125 X 110	16	69	8	285	DIV125110
I	140 X 110	16	76	17	645	DIV140110
IF	140 X 125	16	76	9.5	350	DIV140125
IF	160 X 140	16	86	10	565	DIV160140
	*225 X 200	16	119	13	1380	DIV225200
	250 X 200	10	132	25	3500	DIV250200
	250 X 225	10	132	12	2100	DIV250225
	**280 x 250	4	147	15	2500	DIV280250
	315 x 280	10	165	18	4590	DIV315280

Fig. B

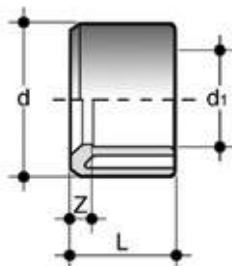

DIV

Переходное кольцо

Клеевое соединение d – для внешнего диаметра, d1 – для внутреннего (fig. B)

	d x d1	PN	L	Z	g	Артикул
I	40 X 20	16	26	9	25	DIV040020
I	40 X 25	16	26	7	24	DIV040025
I	50 X 32	16	31	8.5	35	DIV050032
I	63 X 32	16	38	16	73	DIV063032
I	63 X 40	16	38	11.5	75	DIV063040
I	75 X 50	16	44	13	120	DIV075050
I	90 X 50	16	51	20	200	DIV090050
I	90 X 63	16	51	13	210	DIV090063
I	110 X 63	16	61	23	340	DIV110063
I	110 X 75	16	61	17	360	DIV110075
I	140 X 90	16	76	25	730	DIV140090
I	160 X 90	16	86	35	1040	DIV160090
I	160 X 110	16	86	24	945	DIV160110
	*180 X 160	4	96	10	710	DIV180160
	*200 X 160	16	106	20	1310	DIV200160
	*200 X 180	4	106	10	870	DIV200180
	225 X 160	16	119	33	1840	DIV225160
	250 X 160	10	132	45	3100	DIV250160
	*250 X 180	4	132	36	3100	DIV250180
	*280 X 200	4	146	40	4100	DIV280200
	280 x 225	10	147	27	4300	DIV280225
	315 x 200	10	165	58	8650	DIV315200
	315 x 225	10	165	45	8100	DIV315225
	315 x 250	10	165	33	5080	DIV315250

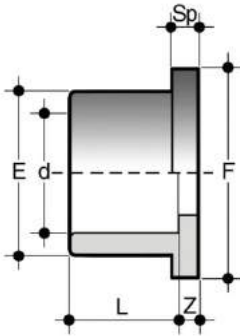

QPV

Бурт с гладкой поверхностью, в соответствии с DIN 8063 PN 10/16

	d	DN	PN	E	F	L	Sp	Z	g	Артикул
I	20	15	16	27	34	16	7	3.5	10	QPV020
I	25	20	16	33	41	19	7	3	16	QPV025
I	32	25	16	41	50	22	7	3	25	QPV032
I	40	32	16	50	61	26	8	3	40	QPV040
I	50	40	16	61	73	31	8	3	62	QPV050
I	63	50	16	76	90	38	9	3	105	QPV063
I	75	65	16	90	105	44	10	3	160	QPV075
I	90	80	16	108	125	51	10	5	275	QPV090
I	110	100	16	131	150	61	12	4	445	QPV110
I	125	125	16	147	168	69	13	5	750	QPV125
I	125	***125	16	165	188	69	13	11	760	QPV125FKE
I	140	125	16	165	188	76	14	5	790	QPV140
	160	150	16	188	212	86	16	4.5	1140	QPV160
	200	***200	16	248	273	106	30	24	2700	QPV200FKE
	200	*200	16	230	254	106	18	5.5	1840	QPV200
	355	**350	4	386	413	184	29	8	5400	QPV355
	400	**400	4	430	483	206	26	12	6500	QPV400
	450	**450	4	486	538	-	19	8	5200	QPV450
	500	**500	4	532	574	-	18	-	3000	QPV500

I: IIP 122

*reduced safety factor

**resale product

***special stubs for butterfly valves FK-FE

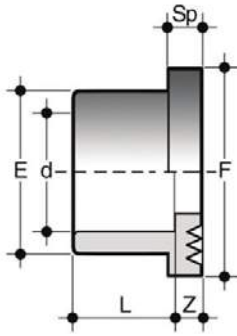

QRV

Бурт с зубчатой поверхностью, в соответствии с DIN 8063 PN 10/16, втулочное окончание для клеевого соединения

	d	DN	PN	E	F	L	Sp	Z	g	Артикул
I	40	32	16	50	61	26	8	3	40	QRV040
I	50	40	16	61	73	31	8	3	62	QRV050
I	63	50	16	76	90	38	9	3	105	QRV063
I	75	65	16	90	105	44	10	3	160	QRV075
I	90	80	16	108	125	51	10	5	275	QRV090
I	110	100	16	131	150	61	12	4	445	QRV110
I	125	125	16	147	168	69	13	5	750	QRV125
I	140	125	16	165	188	76	14	5	790	QRV140
I	160	150	16	188	212	86	16	4.5	1140	QRV160
	200	*200	16	230	254	106	18	5.5	1840	QRV200
	225	*200	16	245	273	119	25	5.5	1750	QRV225
	250	*250	16	270	306	131	20	8.5	2140	QRV250
	280	250	10	307	327	147	32	14.5	3650	QRV280
	315	300	10	346	377	165	32	16	4950	QRV315

I: IIP 122

*reduced safety factor

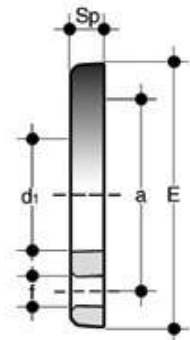

ODV

Фланец свободный для буртов QPV, QRV, QLV EN/ISO/DIN Drilling: - PN 10/16 up to DN150
- PN 10 from DN200

	d	DN	*PMA	a	b	d1	E	f	Sp	U	** (Nm)	g	Артикул
I	20	15	10	65	M12 x 70	28	96	14	11	4	<10	60	ODV020
I	25	20	10	75	M12 x 70	34	107	14	12	4	<10	85	ODV025
I	32	25	10	85	M12 x 70	42	117	14	14	4	10	120	ODV032
I	40	32	10	100	M16 x 85	51	143	18	15	4	13	190	ODV040
I	50	40	10	110	M16 x 85	62	153	18	16	4	13	225	ODV050
I	63	50	10	125	M16 x 95	78	168	18	18	4	15	280	ODV063
I	75	65	10	145	M16 x 95	92	188	18	19	4	17	390	ODV075
I	90	80	10	160	M16 x 105	109	203	18	20	8	18	460	ODV090
I	110	100	10	180	M16 x 105	132	222	18	22	8	20	515	ODV110
I	125	125	10	210	M16 x 115	149	250	18	26	8	25	960	ODV125
I	140	125	10	210	M16 x 120	166	251	18	26	8	25	715	ODV140
I	160	150	10	240	M20 x 135	189	290	22	29	8	30	915	ODV160
I	200	200	10	295	M20 x 140	235	340	22	30	8	45	1210	ODV200
	225	200	10	295	M20 x 140	252	340	22	30	8	50	1090	ODV225
	250	250	10	350	M20 x 150	278	396	22	34	12	60	1790	ODV250
	280	250	10	350	M20 x 160	309	396	22	35	12	70	1880	ODV280
	315	300	10	400	M20 x 180	349	465	22	40	12	50	3050	ODV315
	355	***350	4	460	M20 x 180	386	505	22	32	16	70	3600	ODV355
	400	***400	4	515	M22 x 180	434	565	25	33	16	55	4500	ODV400
	450	***450	4	565	M22 x 160	489	615	25	32	20	65	4400	ODV450
	500	***500	4	600	M20 x 160	540	650	25	31	20	70	4200	ODV500

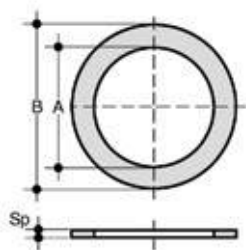

QHV/X

Уплотнительная прокладка из EPDM или FPM для фланцев, в соответствии с DIN 2501, EN1092

d	DN	A	B	Sp	EPDM Артикул	FPM Артикул
16	10	16	27	2	QHVX016E	QHVX016F
20 - 1/2"	15	20	32	2	QHVX020E	QHVX020F
25 - 3/4"	20	24	38.5	2	QHVX025E	QHVX025F
32 - 1"	25	32	48	2	QHVX032E	QHVX032F
40 - 1" 1/4	32	40	59	2	QHVX040E	QHVX040F
50 - 1" 1/2	40	50	71	2	QHVX050E	QHVX050F
63 - 2"	50	63	88	2	QHVX063E	QHVX063F
75 - 2" 1/2	65	75	104	2	QHVX075E	QHVX075F
90 - 3"	80	90	123	2	QHVX090E	QHVX090F
110 - 4"	100	110	148	3	QHVX110E	QHVX110F
125	125	125	166	3	QHVX125E	QHVX125F
140	125	140	186	3	QHVX140E	QHVX140F
160 - 6"	150	160	211	3	QHVX160E	QHVX160F
200	200	200	252	4	QHVX200E	-
225 - 8"	200	225	270	4	QHVX225E	-
250	250	250	305	4	QHVX250E	-

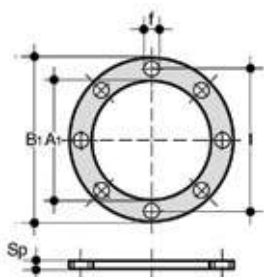

QHV/Y

Уплотнительная прокладка из EPDM для фланцев to DIN2501, EN1092, self-centring for flanges drilled PN10/16 up to DN 150 and PN 10 from DN 200

d	DN	A1	B1	F	I	U	Sp	Артикул
16	10	-	-	-	-	-	-	-
20 - 1/2"	15	17	95	14	65	4	2	QHVV020E
25 - 3/4"	20	22	107	14	76.3	4	2	QHVV025E
32 - 1"	25	28	117	14	86.5	4	2	QHVV032E
40 - 1" 1/4	32	36	142.5	18	101	4	2	QHVV040E
50 - 1" 1/2	40	45	153.3	18	111	4	2	QHVV050E
63 - 2"	50	57	168	18	125.5	4	2	QHVV063E
75 - 2" 1/2	65	71	187.5	18	145.5	4	3	QHVV075E
90 - 3"	80	84	203	18	160	8	3	QHVV090E
110 - 4"	100	102	223	18	181	8	3	QHVV110E
125	125	132	250	18	210	8	3	QHVV125E
140	125	132	250	18	210	8	3	QHVV140E
160 - 6"	150	152	288.5	22	241.5	8	4	QHVV160E
200	200	192	340	22	295	8	4	QHVV200E
225 - 8"	200	215	340	22	295	8	4	QHVV225E
250	250	238	395	22	350	12	4	QHVV250E
280	250	265	395	22	350	12	4	QHVV280E
315	300	290	462	22	400	12	4	QHVV315E
355	350	337	500	22	460	16	2	QHVV355E
400	400	384	555	25	515	16	2	QHVV400E

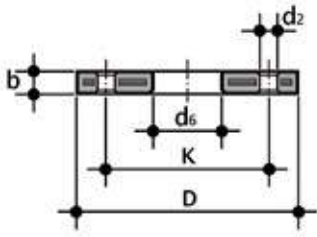

ODB

Фланец армированный PP/FRP, в соответствии с EN/ISO/DIN для буртов QRV, QPV. Drilling: PN 10/16 up to DN 150; PN 10 from DN 200

d	DN	*PM A	b	d2	d6	D	k	M	n	** (Nm)	g	Артикул
20	15	16	12	14	28	95	65	M12	4	10	232	ODB020
25	20	16	14	14	34	105	75	M12	4	15	288	ODB025
32	25	16	14	14	42	115	85	M12	4	15	544	ODB032
40	32	16	16	18	51	140	100	M16	4	20	836	ODB040
50	40	16	16	18	62	150	110	M16	4	25	902	ODB050
63	50	16	19	18	78	165	125	M16	4	35	1074	ODB063
75	65	16	19	18	92	188	145	M16	4	40	1368	ODB075
90	80	16	21	18	109	204	160	M16	8	40	1516	ODB090
***125	100	16	22	18	135	224	180	M16	8	50	1938	ODB125
****180	150	16	27	22	191	285	240	M20	8	60	3298	ODB180
200	200	16	28	22	235	340	295	M20	8	75	5318	ODB200

*maximum pressure values to EN/ISO/DIN. Pay attention to maximum admissible pressure values when selecting gaskets

**nominal tightening torque

*** for use with stubs QPV110, QRV110

**** for use with stubs QPV160, QRV160

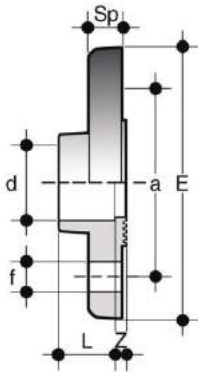

FDV

Соединение фланцевое неподвижное
Drilling: PN 10/16 up to DN 150; PN 10 from DN 200

d	DN	*PM A	a	E	f	L	Sp	Z	** (Nm)	g	Артикул
25	20	10	75	105	14	19	12	4.5	<10	105	FDV025
32	25	10	85	115	14	22	14	4.5	10	150	FDV032
40	32	10	100	140	18	26	15	4.5	13	230	FDV040
50	40	10	110	150	18	31	16	4.5	13	280	FDV050
63	50	10	125	163	18	38	18	4.5	15	390	FDV063
75	65	10	145	185	18	44	19	5	17	525	FDV075
90	80	10	160	200	18	51	20	7	18	710	FDV090
110	100	10	180	220	18	61	22	8	20	955	FDV110

* PMA: maximum admissible working pressure

**nominal tightening torque

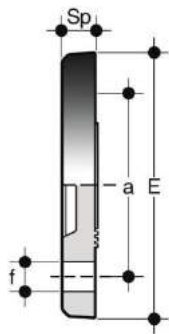

FCV

Глухой фланец

Drilling: PN 10/16 up to DN 175; PN 10 from DN 200

d	DN	*PM A	a	E	f	Sp	U	*** (Nm)	g	Артикул
25	20	10	75	105	14	12	4	<10	95	FCV025
32	25	10	85	115	14	14	4	10	135	FCV032
40	32	10	100	141	18	15	4	13	225	FCV040
50	40	10	110	150	18	16	4	13	270	FCV050
63	50	10	125	165	18	18	4	15	355	FCV063
75	65	10	145	186	18	19	4	17	510	FCV075
90	80	10	160	201	18	20	8	18	675	FCV090
110	100	10	180	221	18	22	8	20	915	FCV110
180	***175	4	270	315	22	30	8	45	3100	FCV180
200-225	***200	4	295	340	22	30	8	60	3800	FCV200

* PMA: maximum admissible working pressure

**nominal tightening torque

***resale product

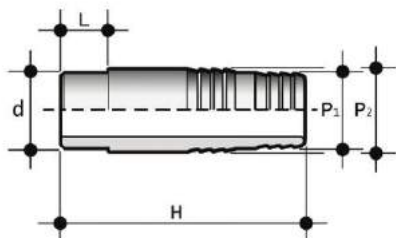

AIV

Штуцер для шланга

d x P2 x P1	PN	H	L	g	Артикул
12 x 14 x 12	16	56	12	6	AIV012014012
16 x 18 x 16	16	60	14	12	AIV016018016
20 x 22 x 20	16	67	16	17	AIV020022020
25 x 27 x 25	16	81	19	26	AIV025027025
32 x 32 x 30	16	97	22	40	AIV032032030
40 x 42 x 40	16	104	26	78	AIV040042040
50 x 52 x 50	16	111	31	113	AIV050052050
63 x 64 x 60	16	123	38	170	AIV063064060

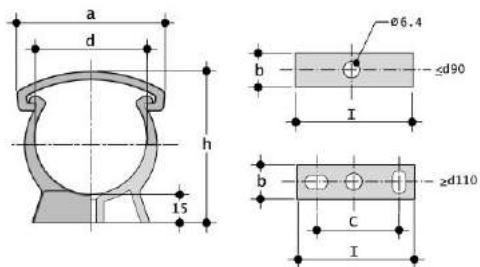

ZIKM

Крепление для труб

d	a	b	c	h	I	Артикул
**16	26	18	-	33	16	ZIKM016
**20	33	14	-	38	20	ZIKM020
**25	41	14	-	44	25	ZIKM025
**32	49	15	-	51	32	ZIKM032
**40	58	16	-	60	40	ZIKM040
**50	68	17	-	71	60	ZIKM050
**63	83	18	-	84	63	ZIKM063
**75	96	19	-	97	75	ZIKM075
**90	113	20	-	113	90	ZIKM090
**110	139	23	40	134	125	ZIKM110
**125	158	25	60	151	140	ZIKM125
**140	177	27	70	167	155	ZIKM140
**160	210	30	90	190	180	ZIKM160
**180	237	33	100	211	200	ZIKM180

*for pipe support systems, refer to guidelines DVS 2210-1 (Planning and execution - above-ground pipe systems)
**resale product

УСТАНОВКА КРЕПЛЕНИЙ

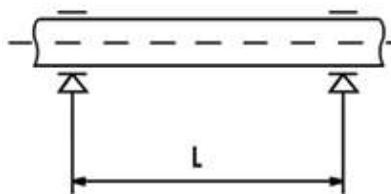

Установка пластиковых трубопроводных систем требует использования опорных креплений.

Расстояние между зажимами зависит от материала трубы, толщины стенки (SDR), температуры поверхности и плотности перемещаемой среды. Перед установкой креплений, проверьте расстояния, приведенные в таблице ниже, как это предусмотрено директивами DVS 2210-01 для водопроводных труб

Если транспортируемая жидкость имеет удельную массу выше 1, расстояние между опорами следует уменьшить во столько раз, во сколько плотность жидкости больше 1. Для вертикальных труб расстояние между точками опоры может быть увеличено на 50%..

For pipes of SDR 13.6 / S 6.3 / PN 16:

d mm	расстояние L в мм, в зависимости от температуры				
	< 20° C	30° C	40° C	50° C	60° C
16	950	900	850	750	600
20	1100	1050	1000	900	700

For pipes of SDR 21 / S 10 / PN 10:

d mm	расстояние L в мм, в зависимости от температуры				
	< 20° C	30° C	40° C	50° C	60° C
25	1200	1150	1050	950	750
32	1350	1300	1250	1100	900
40	1450	1400	1350	1250	1000
50	1600	1550	1500	1400	1150
63	1800	1750	1700	1550	1300
75	2000	1900	1850	1700	1450
90	2200	2100	2000	1850	1550
110	2400	2300	2250	2050	1750
125	2550	2450	2400	2200	1850
140	2700	2600	2500	2300	1950
160	2900	2800	2700	2500	2100
180	3100	2950	2850	2650	2200